



Steuergeräte I

Controllers

ModuLED Control

Modular Constant Voltage LED Control

up to 8-Zone Wi-Fi & RF Control

ModuLED Control is the modular RF & Wi-Fi control solution for constant voltage RGB & single color LED strip. You can wirelessly control an unlimited number of LED strips in a maximum of 8 separate zones. Control options are by use of your smart-phone, tablet or with the available remote- and wall controls.

1. Choose the number of receivers needed. (min. 1 per driver)
2. Choose if you want to use a Wi-Fi interface
3. Choose your mix of controllers

Receiver



Wi-Fi / RF



Download
Easylighting App
for IOS



Download
Easylighting App
for Android

Controllers

RGB



Dim



ModuLED

Wi-Fi & RF Controller

up to 8-Zone

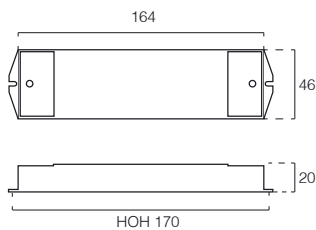
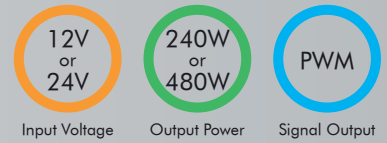

Receiver (S3.10.0422)

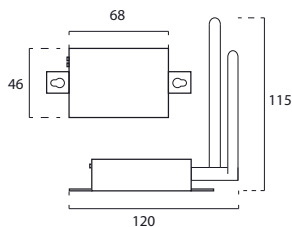

Wi-Fi Control (S3.10.0430)

		S3.10.0422		Product Information
Input Voltage	12V DC	24V DC		
Max. Output Power	240W	480W		
Max. Load Current	4 * 5A			
Channels	4			
LED Connection	Parallel Connection			
		S3.10.0430		Product Information
Input Voltage	12/24V DC			
Operation Frequency	433.92MHz / 868MHz			
Control Zones	8-zone			
Max. RF Range	20m			

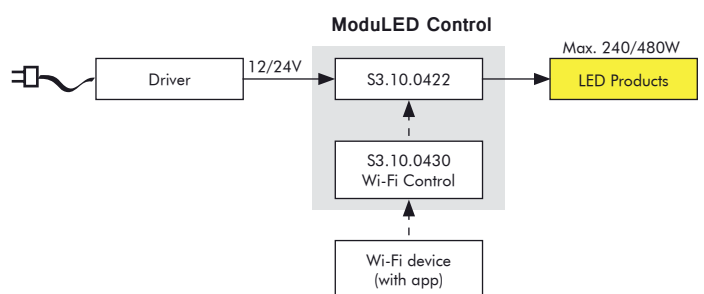

Article No.	Product Name
S3.10.0422	ModuLED Control, RF 12/24V 4 channel receiver, max. 5A per channel, excl. LED driver
S3.10.0430	ModuLED Wi-Fi Control

Product List

ModuLED RGB

RF Controller RGB

up to 8-Zone



Turn Wall (S3.10.0426)*



Touch Wall (S3.10.0428)*



Touch Wall (S3.10.0429)



Remote (S3.10.0424)



Remote (S3.10.0474)



Signal Output



Product Information	S3.10.0424	Battery Type	3*AAA Battery (excluded)
		Operation Frequency	433.92MHz / 868MHz
		Control Zones	8-zone
		Accessories	Wall bracket (included)
S3.10.0474	Battery Type	CR2025 3V (included)	
	Operation Frequency	433.92MHz / 868MHz	
	Control Zones	1-zone	
S3.10.0426	Battery Type	CR2025 3V (included)	
	Operation Frequency	433.92MHz / 868MHz	
	Control Zones	1-zone	
S3.10.0428	Battery Type	CR2025 3V (included)	
	Operation Frequency	433.92MHz / 868MHz	
	Control Zones	1-zone	
S3.10.0429	Input Voltage	230V	
	Operation Frequency	433.92MHz / 868MHz	
	Control Zones	4-zone	
Max. RF Range		20m	

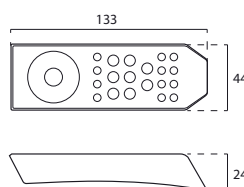
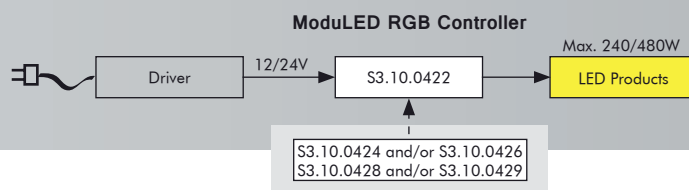

Remote (S3.10.0424)

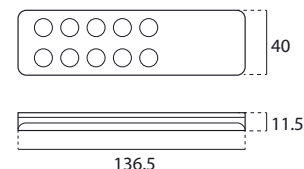

Remote (S3.10.0474)

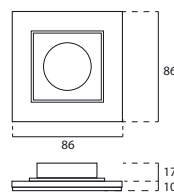

Turn Wall (S3.10.0426)

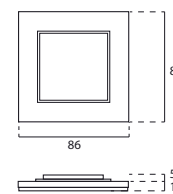

Touch Wall (S3.10.0428)

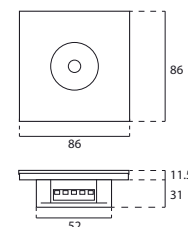

Touch Wall (S3.10.0429)

Product List	Article No.	Product Name
	S3.10.0424	Remote control RF ModuLED DIM Control, 8 zones, battery excluded
	S3.10.0474	Remote control RF ModuLED RGB Control, 1 zone, battery included
	S3.10.0426*	Turn wall control RF ModuLED RGB Control, 1 zone, battery included
	S3.10.0428*	Touch wall control RF ModuLED RGB Control, 1 zone, battery included
S3.10.0429	Touch wall control RF ModuLED RGB Control, 4 zones, 230V	

* also suitable for use in certain wall frames of the brands: Berker, Gira, Jung & Merten.

ModuLED Dim

RF Controller Single Color

up to 5-Zone



Remote (S3.10.0423)



Turn Wall (S3.10.0425)*



Touch Wall (S3.10.0427)*

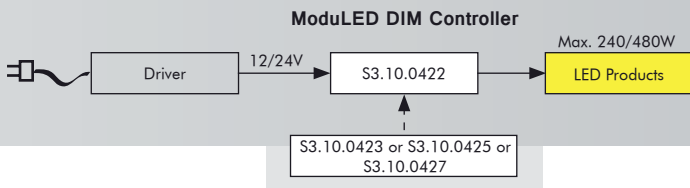

		S3.10.0423	Product Information
Battery Type	CR2025 3V (included)		
Operation Frequency	433.92MHz / 868MHz		
Control Zones	5-zone		
Accessories	Wall bracket (included)		
		S3.10.0425	
Battery Type	CR2025 3V (included)		
Operation Frequency	433.92MHz / 868MHz		
Control Zones	1-zone		
		S3.10.0427	
Battery Type	CR2025 3V (included)		
Operation Frequency	433.92MHz / 868MHz		
Control Zones	1-zone		
Max. RF Range	20m		

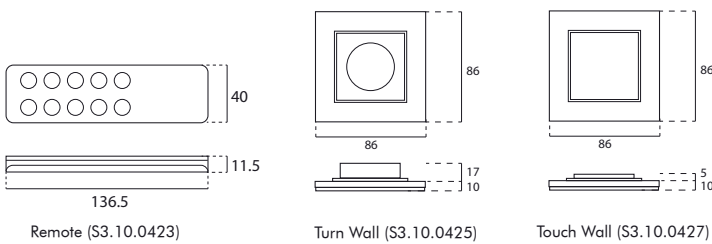

Article No.	Product Name	Product List
S3.10.0423	Remote control RF ModuLED Dim Control, 5 zone, battery included	
S3.10.0425*	Turn wall control RF ModuLED Dim Control, 1 zone, battery included	
S3.10.0427*	Touch wall control RF ModuLED Dim Control, 1 zone, battery included	

* also suitable for use in certain wall frames of the brands: Berker, Gira, Jung & Merten.

Easy Dim

RF Dimmer

5-Zone





12V
or
24V

Input Voltage



240W
or
480W

Output Power



PWM

Signal Output



Product Information	S3.10.0275	Battery Type	CR2025 3V (included)	
		Operation Frequency	433.92MHz / 868MHz	
		Control Zones	5-zone	
		Accessories	Wall bracket (included)	
		Max. RF Range	20m	
	S3.10.0276	Input Voltage	12V DC	24V DC
		Max. Output Power	240W	480W
		Max. Load Current	4 * 5A	
		Channels	4	
		LED Connection	Parallel Connection	

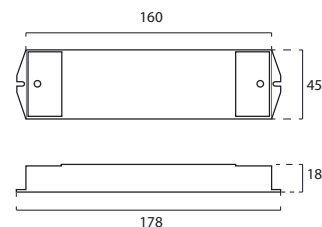

Receiver (S3.10.0276)

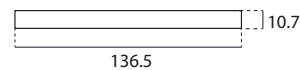
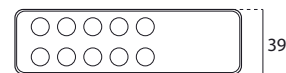

Remote (S3.10.0275)

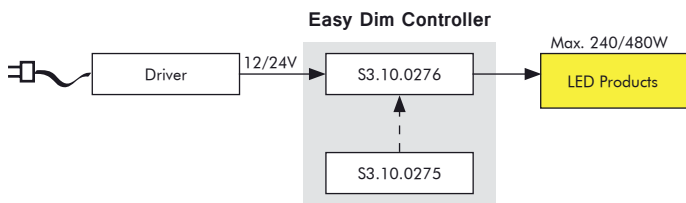

Product List	Article No.	Product Name
	S3.10.0275	RF Remote Control for Easy Dim, including battery
	S3.10.0276	RF Receiver Easy Dim 12/24V max. 4 channels, 5A per channel, excluding driver

Parrot

Data Repeater

4-Channel

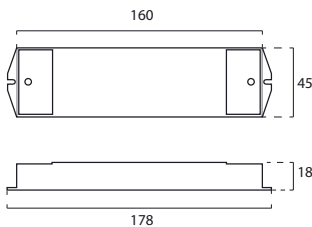
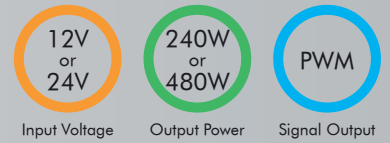

Input Voltage	12V DC	24V DC	Product Information
Max. Output Power	240W	480W	
Max. Load Current	4 * 5A		
Channels	4		
LED Connection	Parallel Connection		
Signal Output	4* PWM		

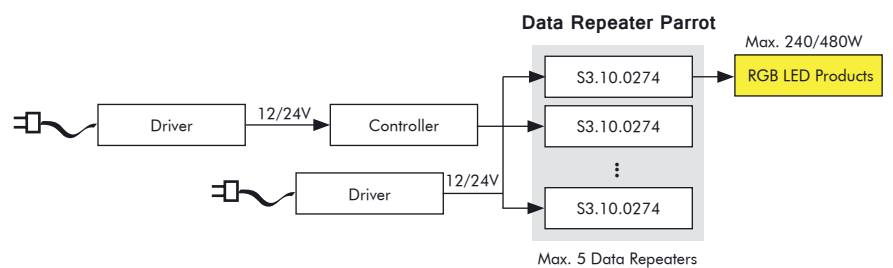

Article No.	Product Name	Product List
S3.10.0274	Datarepeater Parrot 12/24V max. 4 channels, 5A per channel	

Art Touch

DMX Controller

Wall Panel

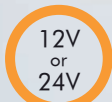

Input Voltage



Output Power



Signal Output



RoHS



IP 20



Product Information

S3.10.0272		-	-
	Input Voltage	12V / 24V DC	
	Signal Output	DMX 512	
S3.10.0273	Input Voltage	12V DC	24V DC
	Max. Output Power	240W	480W
	Max. Load Current	4 * 5A	
	Channels	4	
	LED Connection	Parallel Connection	
	Signal	DMX to PWM Interface	

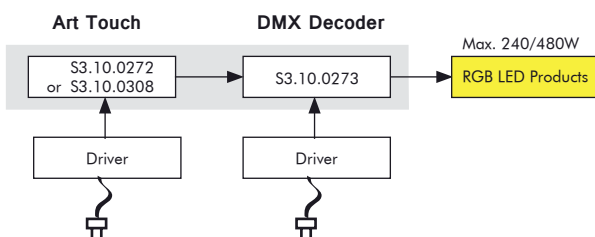
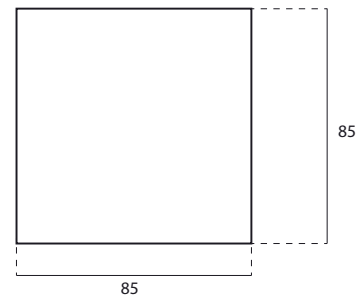

Product List

Article No.	Product Name
S3.10.0272	DMX wall panel Art Touch black, excluding driver
S3.10.0308	DMX wall panel Art Touch white, excluding driver
S3.10.0273	Lumix RGB DMX Controller Decoder 12/24V max. 4 channels, 5A per channel, excluding driver

Lumix DMX

DMX to PWM Controller

3 & 4 Channel

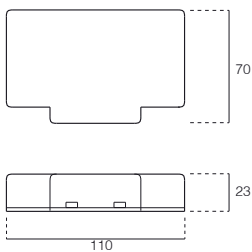
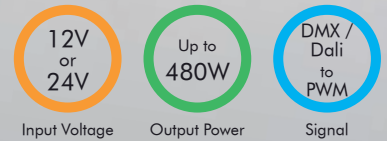

DMX Decoder (S3.10.0179)

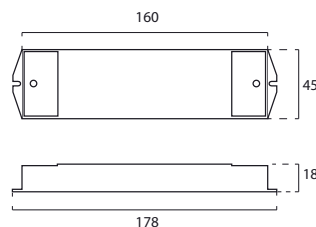

DMX Decoder (S3.10.0273)

Input Voltage	12V DC	24V DC	S3.10.0179
	Max. Output Power	72W	
Max. Load Current	3 * 2A		S3.10.0273
Channels	3		
LED Connection	Parallel Connection		S3.10.0273
Signal Input	DMX / DALI		
Signal Output	3 * PWM		

Input Voltage	12V DC	24V DC	S3.10.0273
	Max. Output Power	240W	
Max. Load Current	4 * 5A		S3.10.0273
Channels	4		
LED Connection	Parallel Connection		S3.10.0273
Signal Input	DMX		
Signal Output	4 * PWM		

Product Information

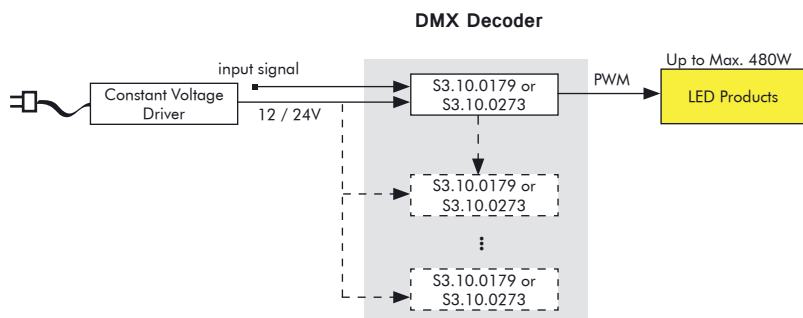

Article No.	Product Name	Product List
S3.10.0179	LED DMX200 controller 24V DC 2A by channel, max.144W DMX512/DALI	
S3.10.0273	DMX Decoder for Lumix RGB DMX,12/24V max. 4 channels, 5A per channel, excluding driver	

Controller for LupaReel AmbiLED

RF Controller

1-Zone



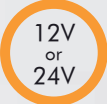

12V
or
24V

Input Voltage



144W
or
288W

Output Power



PWM

Signal Output



Product Information	Remote	Battery Type	3*AAA Battery (excluded)	
		Operation Frequency	433MHz	
		Control Zones	1-zone (no pairing option)	
		Max. RF Range	20m	
Receiver	Input Voltage	12V DC	24V DC	
	Max. Output Power	144W	288W	
	Max. Load Current	2 * 6A		
	Channels	2		
	LED Connection	Parallel Connection		

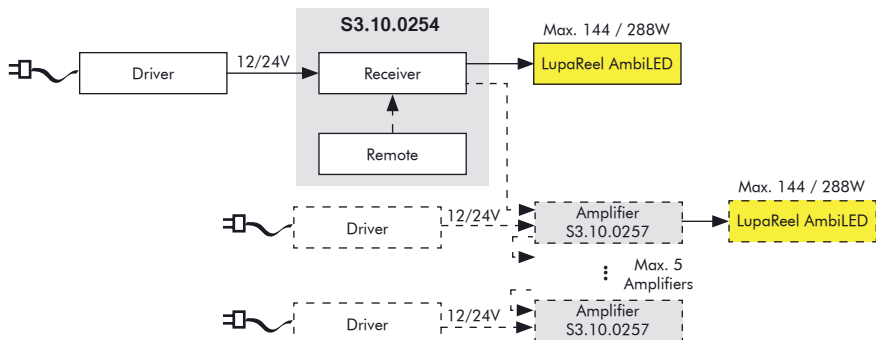
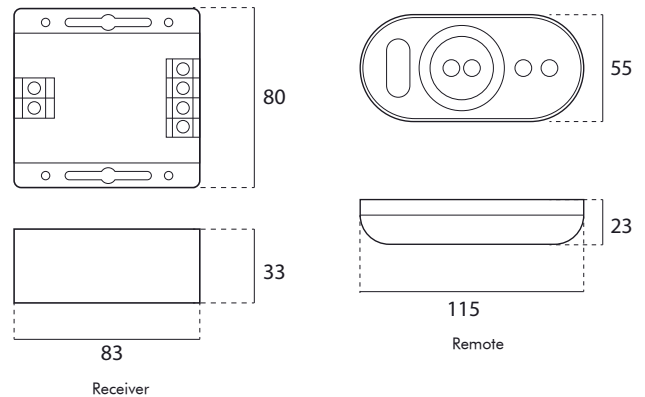

Amplifier(S3.10.0257) for expanding connections

Product List	Article No.	Product Name
	S3.10.0254	LupaReel 12V/24V AmbiLED RF controller excl. driver; including remote (12/24V, 144/288W)
	S3.10.0257	LupaReel 12V/24V AmbiLED Amplifier max. 144W/288W (for expanding connections)

Controller for LupaReel RGB

RF Controller

1-Zone

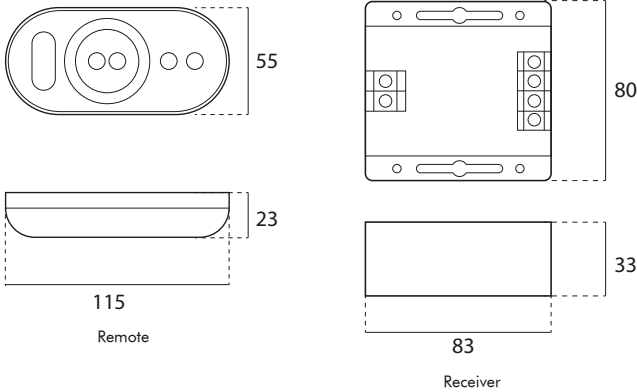
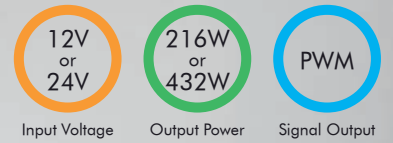

Amplifier(S3.10.0262) for expanding connections

		Remote
Battery Type	3*AAA Battery (excluded)	
Operation Frequency	433MHz	
Control Zones	1-zone (no pairing option)	
Max. RF Range	20m	
		Receiver
Input Voltage	12V DC	24V DC
Max. Output Power	216W	432W
Max. Load Current	3 * 6A	
Channels	3	
LED Connection	Parallel Connection	

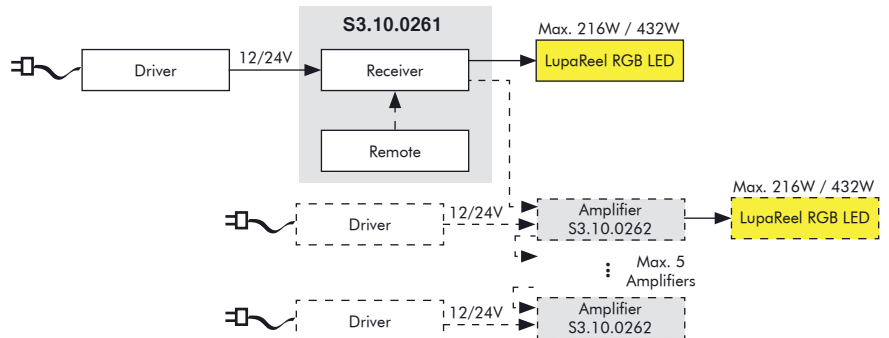

Article No.	Product Name	Product List
S3.10.0261	LupaReel 12V/24V RGB RF controller excl. driver; including remote max. (12V/24V, 216/432W)	
S3.10.0262	LupaReel 12V/24V RGB Amplifier max. 216W/432W	

Dim Interface

Dim Controller

Dali / 1~10 V

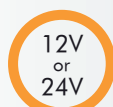

Input Voltage

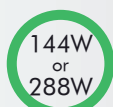

Output Power



Signal



Product Information	Input Voltage	12V DC	24V DC
	Max. Output Power	144W	288W
	Max. Load Current	1 * 12A	
	Channels	1	
	LED Connection	Parallel Connection	
	Signal Output	PWM	

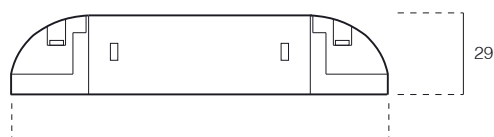

138

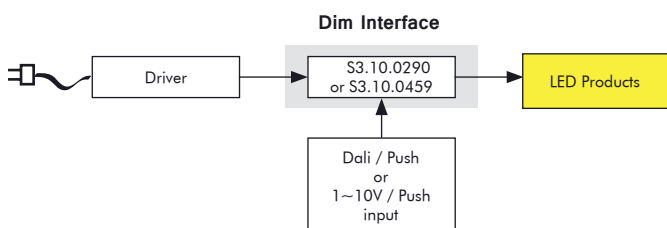

Product List	Article No.	Product Name
	S3.10.0290	Dim Interface Dali & Push 12/24V max. 1 channel, 12A, excluding driver
	S3.10.0459	Dim Interface 1-10V & Push 12/24V max. 1 channel, 12A, excluding driver

Fade Dimmer

Dim Controller

1~10 V

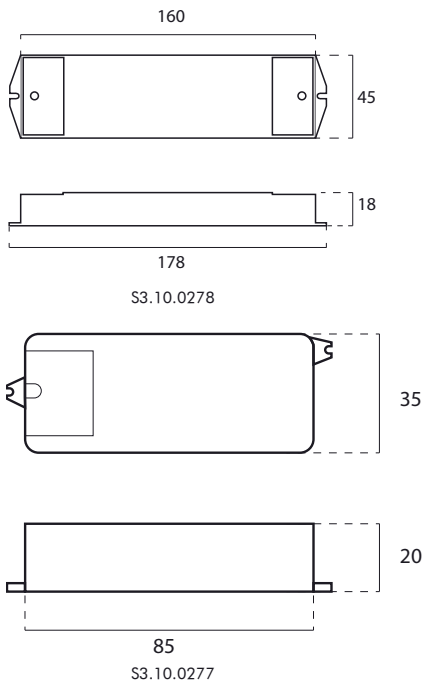

Type	S3.10.0277	S3.10.0278	Product Information
Input Voltage	12 / 24V DC		
Channels	Max. 1	Max. 4	
Max. Load Current	1 * 8A	4 * 5A	
Max. Output Power	96/192W	240/480W	
Dimmable with	1CH 1~10V	4CH 1~10V	
Signal Output	1CH PWM	4CH PWM	
LED Connection	Parallel Connection		

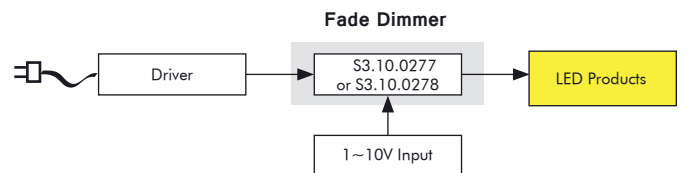

Article No.	Product Name	Product List
S3.10.0277	Fade Dimmer Control 1~10V 12/24V max. 1 channel, 8A, excluding driver	
S3.10.0278	Fade Dimmer Control 4 * 1~10V 12/24V max. 4 channels, 5A per channel, excluding driver	

Legende



EG-Norm konform



entspricht EG-Richtlinie 2002 / 95 / ED (RoHS)



Anwendung für Innenräume



Schutzklasse 1



Schutzklasse 2



Schutzklasse 3



maximal schwenkbar



maximal drehbar



Mindestabstand: Lampe - Objekt



Schutzart; hier z. B. IP20



verwendbar für Installation auf normal enflambaren Oberflächen



unabhängiges Zubehör

Unsere Partner

